

SBC9261-I Single Board Computer

- ARM926EJ-S Single-board Computer based upon Atmel AT91SAM9261S
- CAN, USB Host/Device, Ethernet, Serial Ports, LCD, VGA, SD, Jtag...
- Flexible Design with Compact CPU Board Mounted on Expansion Board
- Support Linux 2.6 and WinCE 6.0 OS

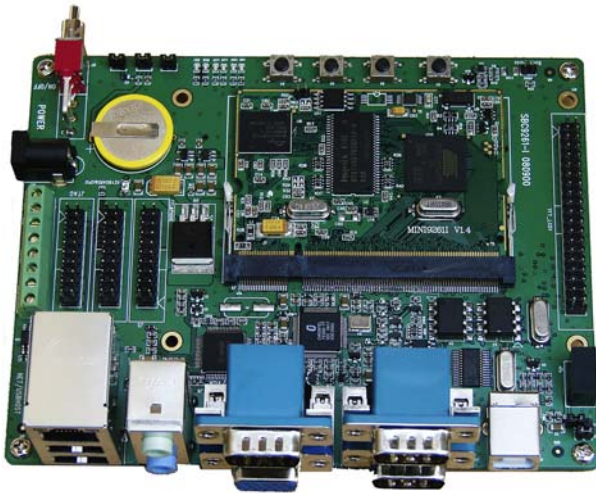

Embest SBC9261-I Single Board Computer

Description

Embest SBC9261-I is a low power, high performance single board computer based on Atmel AT91SAM9261S microcontroller intended for applications like HMI (Human Machine Interface), data acquisition system, handheld devices, and intelligent instruments. It has a flexible design with a tiny CPU board Mini9261-I mounted directly onto the expansion board through a DIMM 200-pin connector.

The daughter board of the SBC9261-I has AT91SAM9261S processor and memories on board. It exposes most features of the AT91SAM9261S through DIMM 200-pin. The mother board integrates a rich set of peripherals and interfaces including Ethernet, USB Host & Device, CAN, RS232/TTL/RS422 Serial ports, Audio, LCD, Keyboard, SD/MMC, Buttons, LEDs and etc.

Embest offers Linux 2.6.24 BSP and WinCE 6.0 BSP for this board. Customers can use it already or use it for your design reference.

Hardware Features

The Atmel AT91SAM9261S processor is an ARM926EJ-S based high-performance 32-bit RISC Microcontroller with 16K byte instruction and 16K byte data cache memories; it is pin-to-pin compatible with the AT91SAM9261. It has additional 32K Bytes ROM, 16K Bytes SRAM embedded memories and can operate at 210 MIPS with a 190 MHz clock. Its extensive peripheral set includes USB 2.0, External Bus Interface, LCD Controller, Bus Matrix, System Controller, Reset Controller, Shutdown Controller, Clock Generator, Power Management Controller, Advanced Interrupt Controller, Debug Unit, Periodic Interval Timer, Watchdog Timer, Real-Time Timer, Three 32-bit PIO Controllers, Nineteen Peripheral DMA Channels (PDC), Multimedia Card Interface (MCI), Three Synchronous Serial Controllers (SSC), Three Universal Synchronous/Asynchronous Receiver Transmitters (USART), Two Master/Slave Serial Peripheral Interface (SPI), One Three-channel 16-bit Timer/Counters (TC), Two-wire Interface (TWI), IEEE 1149.1 JTAG Boundary Scan.

The SBC9261-I has a super tiny CPU board integrated with AT91SAM9261S microcontroller, Nor Flash, Nand Flash, DataFlash, EEPROM and SDRAM on it, which exposes many of these features to the user in support of developing specific solutions. The CPU board can be mounted directly onto the expansion board through a SO DIMM 200-pin connector. This board is characterized as follows:

- Dimensions: 141.4 x 109.5mm (expansion board), 67.7 x 47mm (CPU board)
- Working temperature: 0~70 Celsius
- Power supply: +12V
- Atmel AT91SAM9261S (ARM926EJ-S core with MMU capable of 200 MHz operation, AT91SAM9261 is compatible)
- 64Mbyte SDRAM
- 128Mbyte Nand Flash (bootable, selected through jumper, support 256MB for option)
- 4Mbyte Nor Flash (support 8MB for option)
- 4Mbyte SPI serial DataFlash (bootable, selected through jumper)
- 1Kbit EEPROM (DS2431)
- 1 2*20-pin LCD interface (STN or TFT, support resolution up to 2048 x 2048)
- Touch panel (4-channel 12-bit ADC)
- 1 VGA display port
- 1 10M/100M Ethernet interface (RJ45)
- 4 serial ports (one 9-wire RS232 serial port, one 5-wire RS232/TTL serial port, one 3-wire RS232/TTL serial port, one RS485 serial port or one 3-wire TTL serial port)
- 2 USB host and 1 USB device
- 1 SPI interface (multiplex with CAN interface)
- 4 x 4 keyboard interface
- Audio Input/Output
- RTC (battery backed)
- 1 20pin (2.0mm space) standard JTAG interface
- SD / MMC card socket
- 2 programmable LEDs
- 2 power indicators
- 4 buttons (one for Wakeup, one for Reset)
- 1 Power switch
- 1 Reset button

- 13 GPIOs
- 1 20pin standard JTAG interface

The Daughter Board (Mini9261-I)

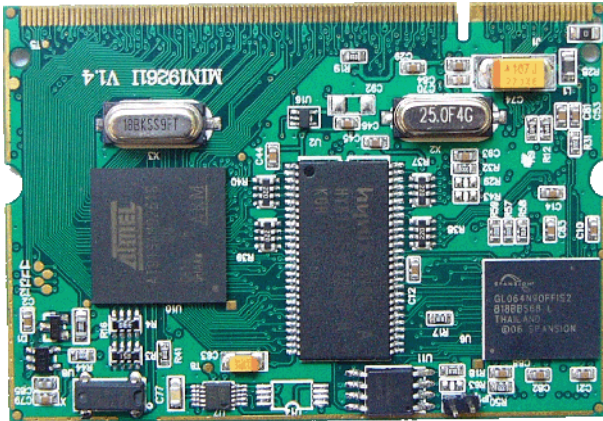

Top View

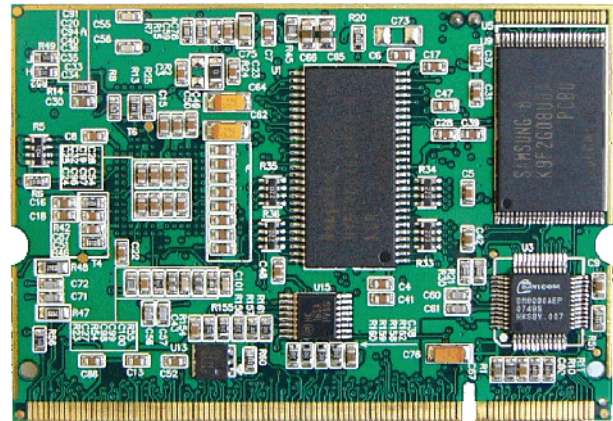

Bottom View

- ✓ Dimensions: 67.6mm x 47mm
- ✓ Temperature: 0~+70°C
- ✓ Atmel AT91SAM9261S microcontroller based on the ARM926EJ-S processor with MMU
- ✓ (AT91SAM9261 is compatible)
 - DSP Instruction Extensions
 - ARM Jazelle® Technology
 - 16 Kbyte Data Cache, 16 Kbyte Instruction Cache, Write Buffer
 - 210 MIPS at 190 MHz
 - Embedded ICE
 - 32 Kbytes internal ROM
 - 16 Kbytes internal SRAM
- ✓ 64Mbyte SDRAM
- ✓ 128Mbyte Nand flash (support 256MB for option)
- ✓ 4Mbyte Nor Flash (bootable, selected through jumper, support 8MB for option)
- ✓ 1Kbit EEPROM (DS2431)
- ✓ 4Mbyte SPI Serial DataFlash (bootable, selected through jumper)
- ✓ On-chip PLL generates the 18.432MHz OSC up to operate MCU at up to 200MHz
- ✓ 32768Hz RTC (Battery backed)
- ✓ One 10M/100M Ethernet Controller (DM9000AEP)
- ✓ I/O and all other hardware interfaces expansions via DIMM 200-pin
- ✓ Single 3.3V power supply

Note: Detailed information about the CPU board Mini9261-I, please refer to Embest website:
<http://www.embedinfo.com/english/Product/mini9261-I.asp>

Software Features

OS	Item	Feature	Description
LINUX	Bootloader	Version	u-boot 1.1.5
		Boot Mode	Support booting from Dataflash, Norflash or Nandflash
		Download Mode	Support download kernel and file system from SAM-BA and Ethernet
	Kernel	Version	Linux 2.6.24
		Serial	Three serial ports drivers
		RTC	RTC driver
		Ethernet	10/100M Ethernet driver (DM9000)
		LCD&TSP	TFT LCD and touch screen driver
		Audio	Audio out driver
		SD card	SPI mode, driver support hot plug
		USB Host	USB Host driver
		VGA	VGA driver
		Keypad	4x4 keyboard driver
		CAN	Multiplex with SPI, provided driver and test programs
GPIO	GPIO driver		
File system	File system	yaffs2 file system, can be read and written	
Graphic libraries	Qt/Embedded Qtopia	Already ported	
WINCE	eboot	Version	Eboot (wince 6.0)
		Boot mode	Support booting from Dataflash or NandFlash
		Download Mode	Support downloading image from Ethernet, VS2005 and SAM-BA
	OS	Version	WINCE 6.0
		Serial	Three serial port driver
		RTC	RTC driver
		Ethernet	10/100M Ethernet driver (DM9000A)
		LCD&TSP	TFT LCD and touch screen driver
		Audio	Audio out driver
		SD Card	SPI mode, driver supports hot plug
		USB Host	USB Host driver
		VGA	VGA driver
		GPIO	GPIO driver
		Keypad	4x4 keyboard driver
CAN	Multiplex with SPI, provided with driver		

Function Diagram

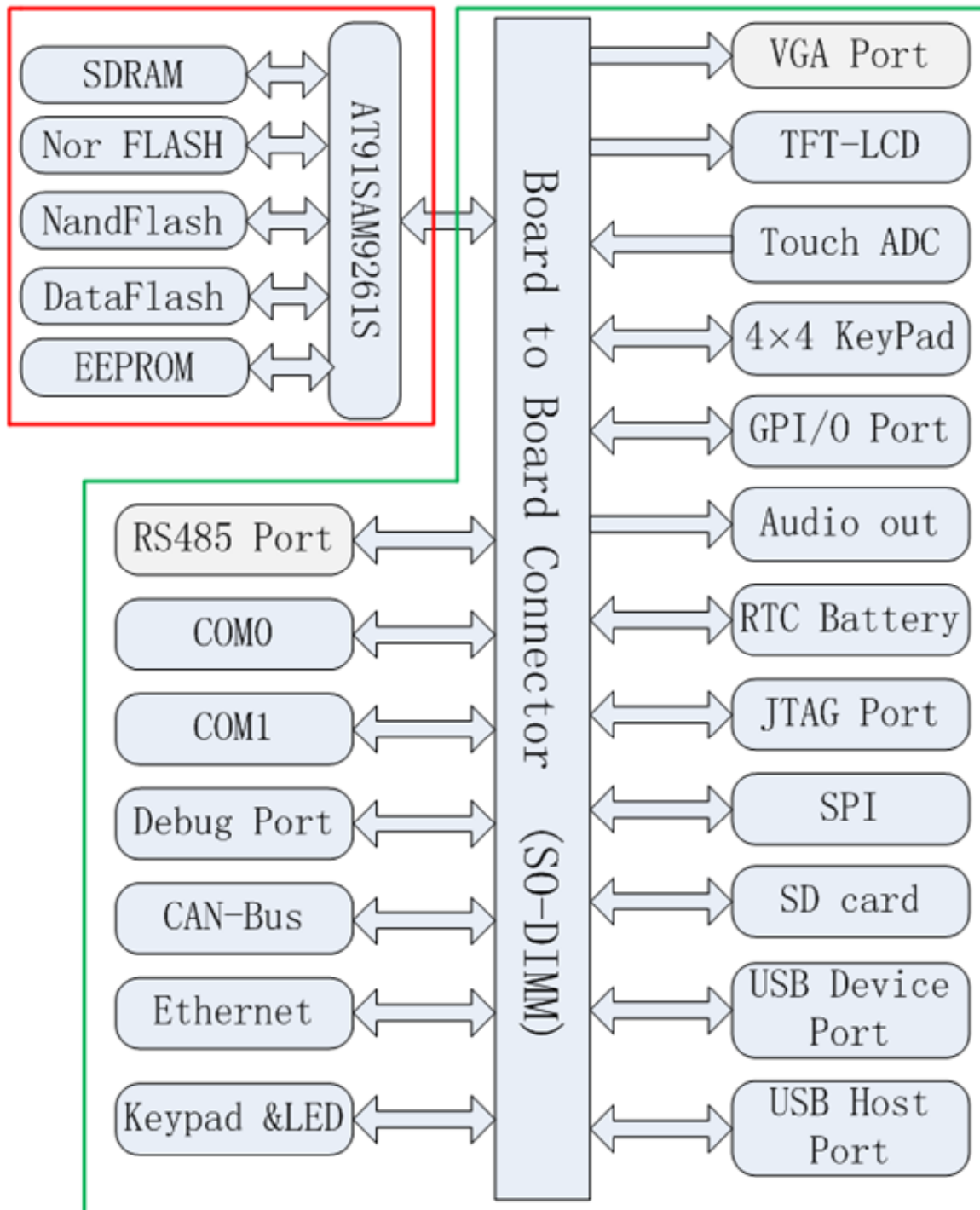

Daughter Board

Mother Board

Dimension (including the Mother board and the Daughter board)

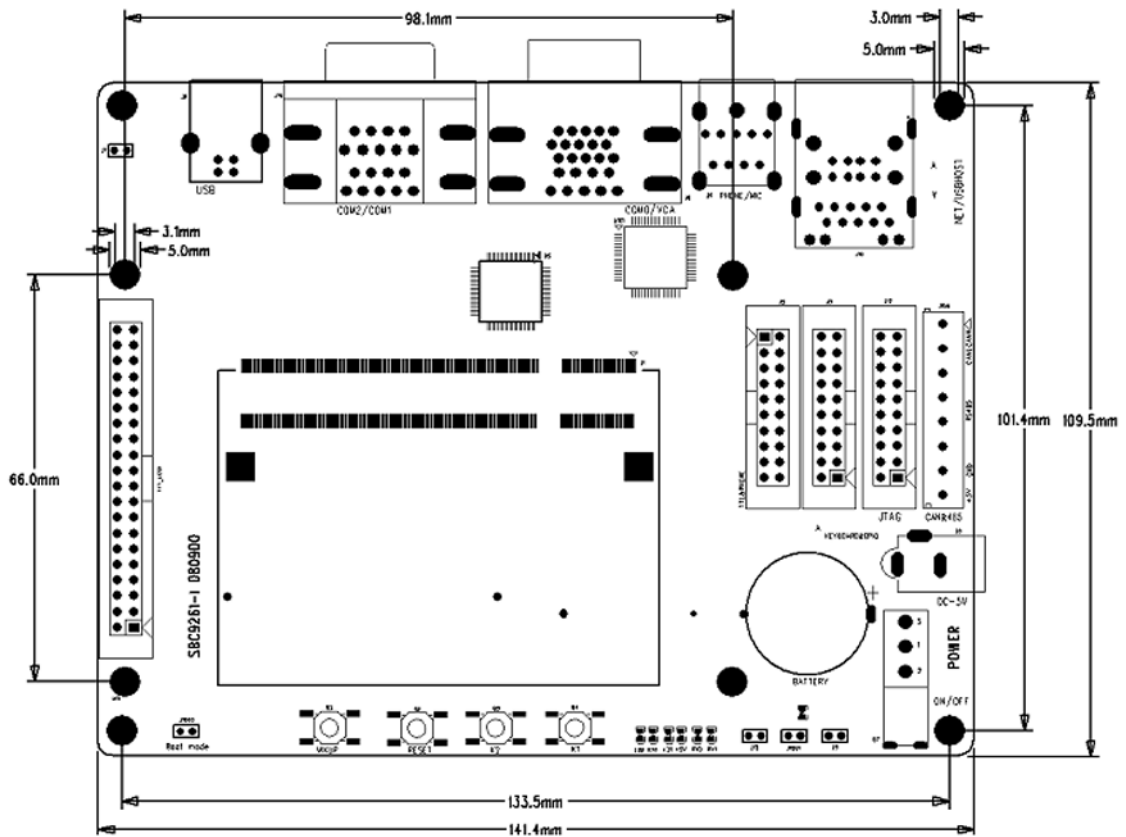

Expansion Board

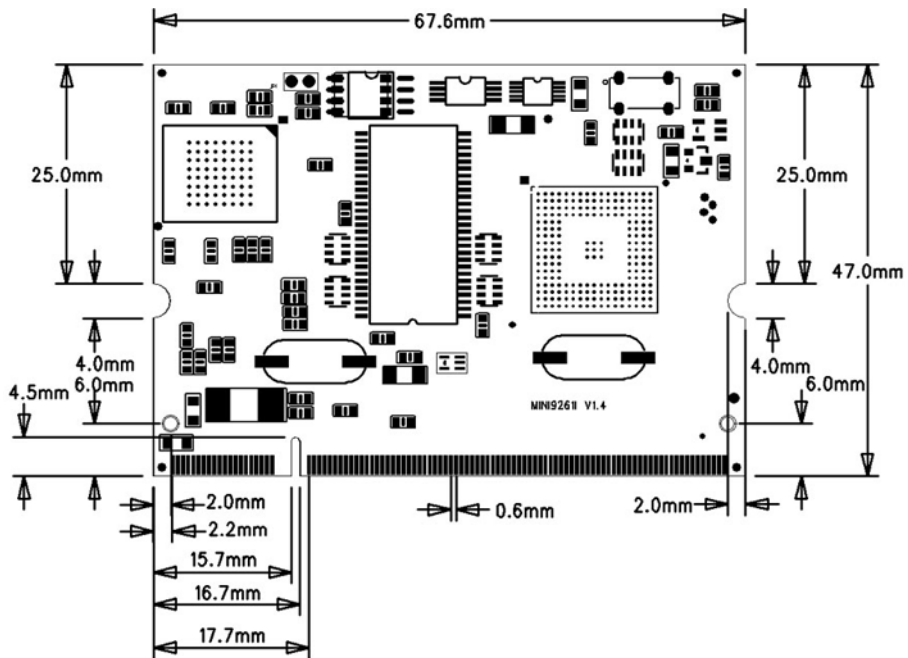

CPU board

Layout of the Expansion Board (including top and bottom)

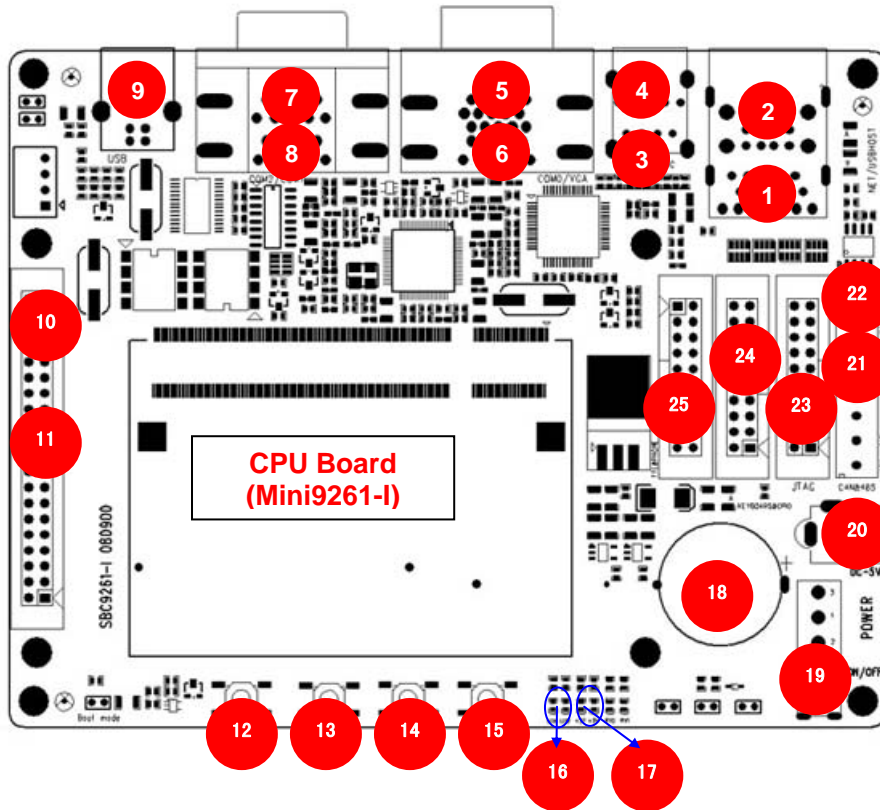

Top View

1	Ethernet port (RJ45)
2	Two USB Host
3	Audio in (Mic)
4	Audio out (Phone)
5	Serial port (COM0)
6	VGA interface
7	Serial port (COM2)
8	Serial port (COM1)
9	USB Device
10	Touch Screen
11	TFT LCD interface
12	Button (Wakeup)
13	Button (Reset)
14	Button (user defined)
15	Button (user defined)
16	Two LEDs
17	Two Power indicators
18	Battery
19	Power switch
20	DC-5V jack
21	RS485 Serial port
22	CAN2.0 interface
23	JTAG interface
24	Keyboard & GPIO
25	SPI interface
26	SD/MMC card socket

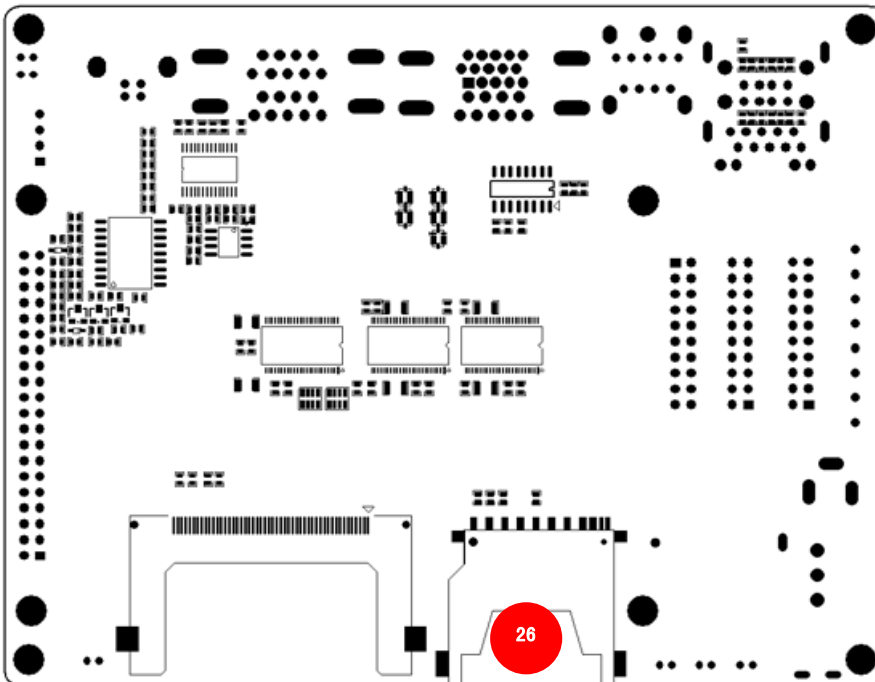

Back View

SO-DIMM 200pin Board-to-Board Connector

The daughter board of the SBC9261-I is connected to the mother board via a SO-DIMM 200-pin connector, which is mounted on your mother board. Signals routed to the connector please refer to the file [MINI9261I_connector.pdf](#) on Embest website.

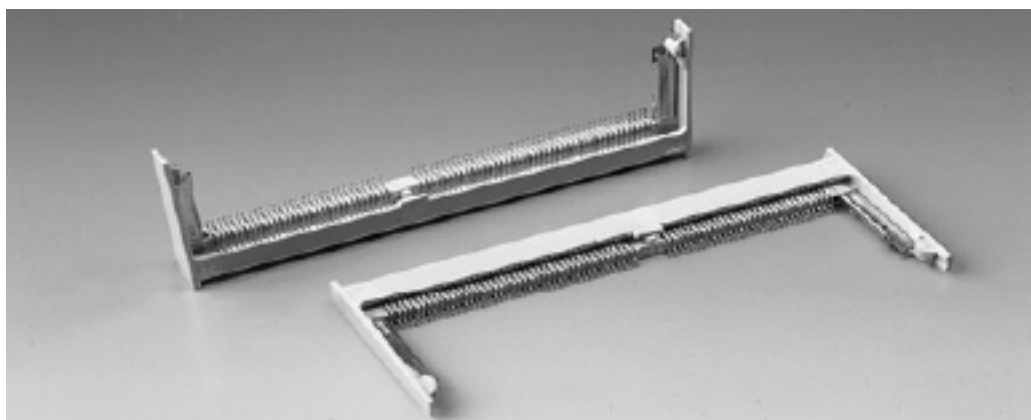

Order Information

Order No.	MH11
Item	Embest SBC9261-I Single Board Computer
Price	Please contact us for detailed information.
Hardware	<ul style="list-style-type: none"> ● SBC9261-I board (including the CPU board Mini9261-I and the expansion board) ● 1 serial cable ● 1 net cable ● 1 USB cable ● 12V power adapter ● 1 CD with product reference
Software and Documents	<ul style="list-style-type: none"> ● Documents (user manual, schematic drawing in PDF format, Datasheet) ● WinCE.net 6.0 BSP ● Linux 2.6.24 BSP
Optional hardware	<ul style="list-style-type: none"> ● 3.5" TFT LCD (resolution: 240*320) ● 4.3"LCD (resolution: 480*272) ● 5.6"LCD (resolution: 640*480) ● 7"LCD (resolution: 800*480)



Embest Info&Tech Co., LTD.

Room 509, Luohu Science&Technology Building,
#85 Taining Rd., Shenzhen, Guangdong, China 518020

Tel: +86-755-25635656/25635626

Fax: +86-755-25616057

Email: market@embedinfo.com

<http://www.embedinfo.com/english>

<http://www.armkits.com>