

Embest Mini9261-I Processor Card

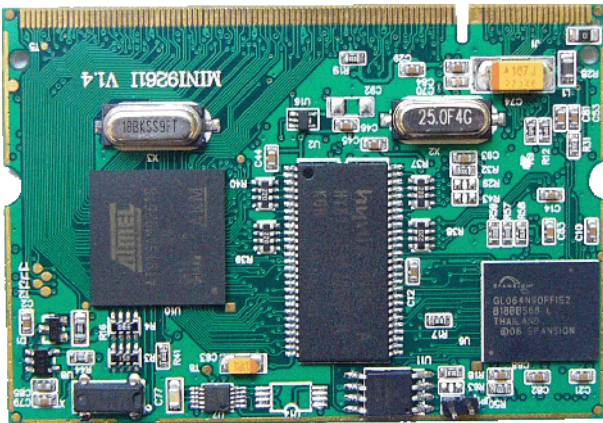

Top View

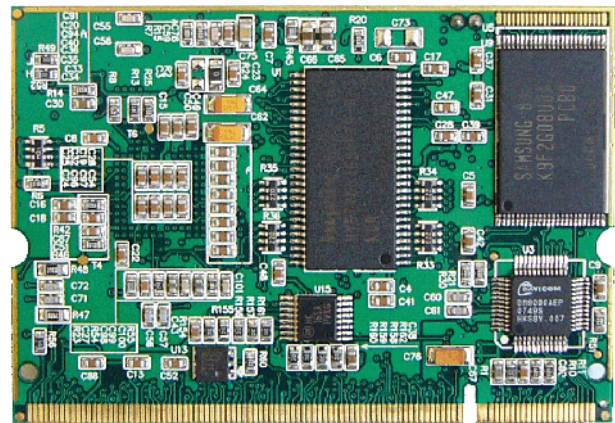

Bottom View

Features

- Dimensions: 67.6mm x 47mm
- Temperature: 0~+70°C
- Atmel AT91SAM9261S microcontroller based on the ARM926EJ-S processor with MMU (AT91SAM9261 is compatible)
 - DSP Instruction Extensions
 - ARM Jazelle® Technology
 - 16 Kbyte Data Cache, 16 Kbyte Instruction Cache, Write Buffer
 - 210 MIPS at 190 MHz
 - Embedded ICE
 - 32 Kbytes internal ROM
 - 16 Kbytes internal SRAM
- 64Mbyte SDRAM
- 128Mbyte Nand flash (support 256Mbyte for option)
- 4Mbyte Nor Flash (bootable, selected through jumper, support 8Mbyte for option)
- 1Kbit EEPROM (DS2431)
- 4Mbyte SPI Serial DataFlash (bootable, selected through jumper)
- On-chip PLL generates the 18.432MHz OSC up to operate MCU at up to 200MHz
- 32768Hz RTC
- One 10M/100M Ethernet Controller (DM9000AEP)
- I/O and all other hardware interfaces can be extended via DIMM 200-pin
- Single 3.3V power supply

General Description

The Embest Mini9261-I processor card provides an ultra-low power solution for your next embedded design. The tiny CPU module supports the Atmel AT91SAM9261S ARM926EJ-S based 32-bit RISC microcontroller. It has a DIMM 200-pin connector on board which can help implement all features of the AT91SAM9261S. User can insert this module into your expansion boards via this connector for different applications. Embest also designed one expansion board for the Mini9261-I and offers Linux 2.6.24 BSP with the board, customers can use the board kit already if cater to your needs.

Function Diagram

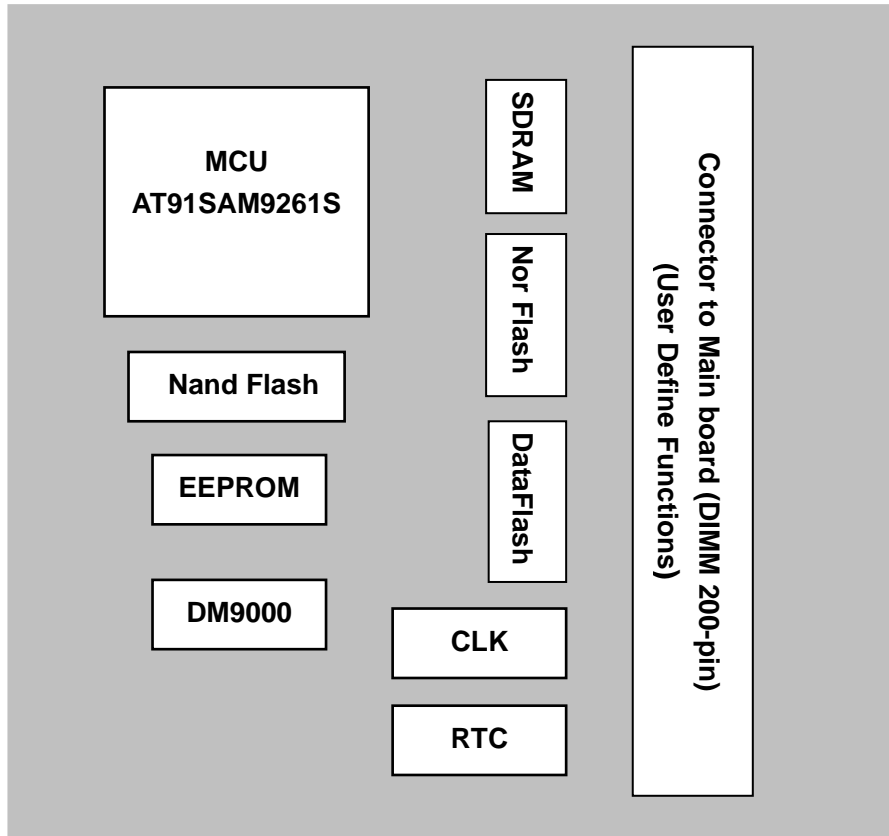

Dimension of Mini2410-III

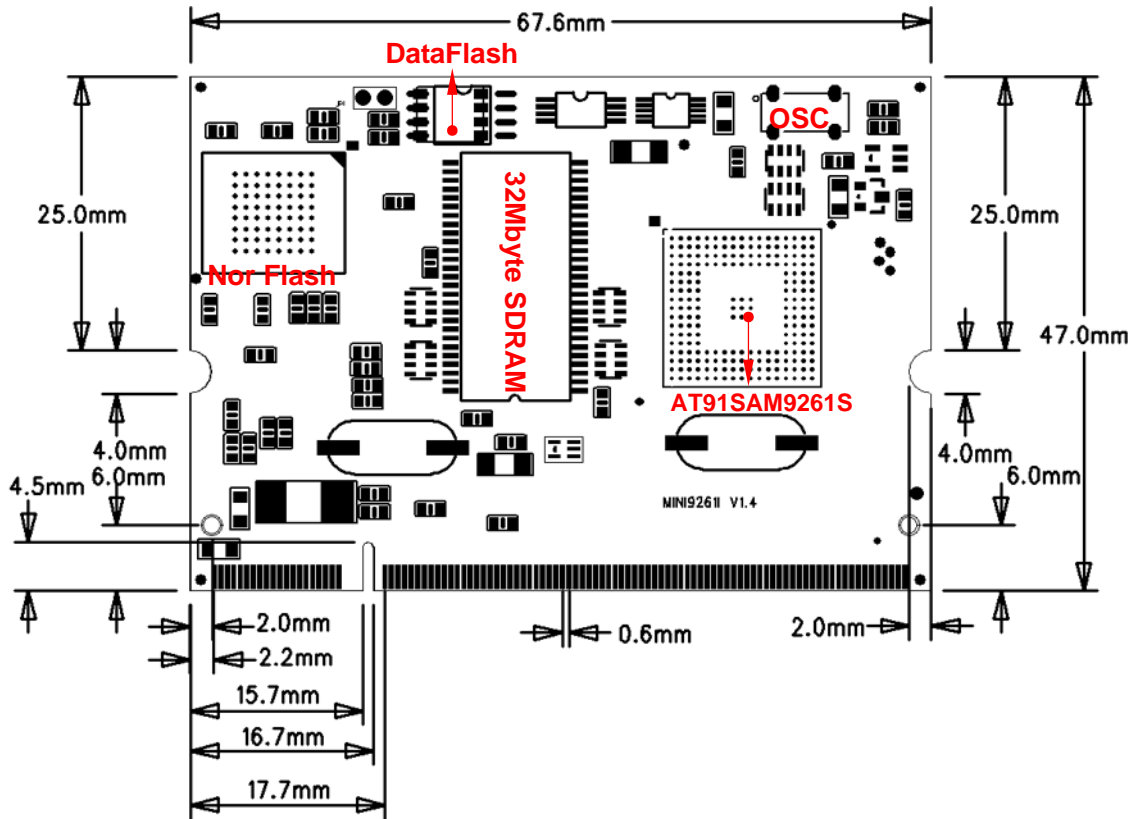

Top View

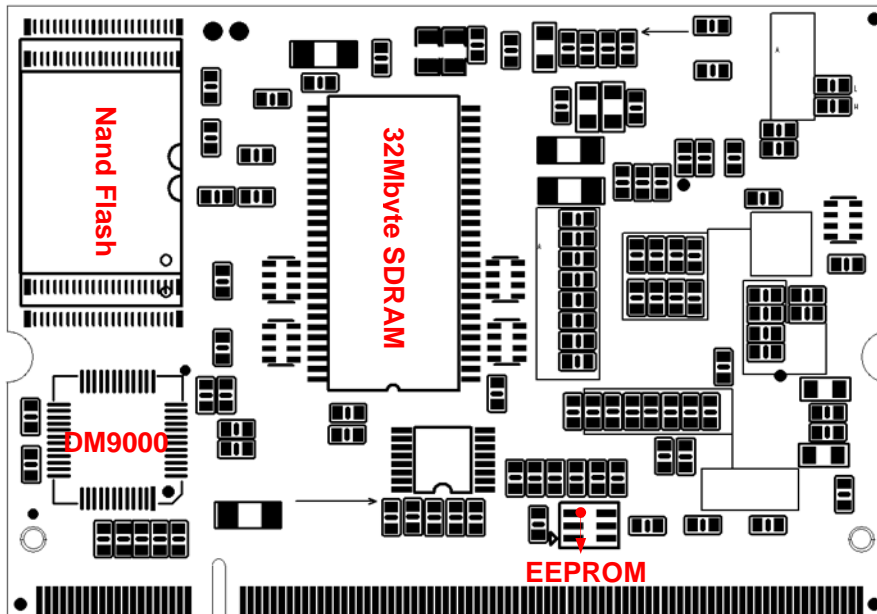

Bottom View

SO-DIMM 200pin Board-to-Board Connector

Embest Mini9261-I processor card is connected to mainboard via DIMM 200-pin to insert into a SO-DIMM socket 200-pin, which is mounted on your mainboard. User can use the processor card conveniently for different applications. Embest also design a mainboard to using with the Mini9261-I processor card together, you can get more information about [SBC9261-I](#) on Embest website, which implements many functions of AT91SAM9261S.

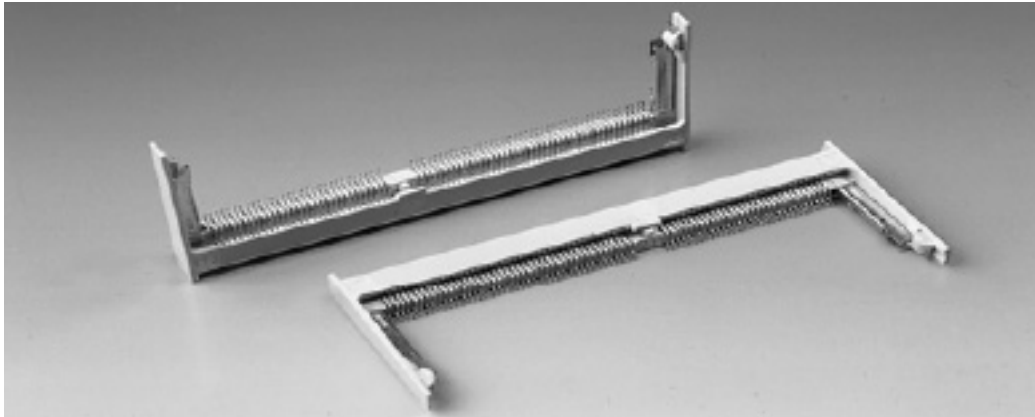

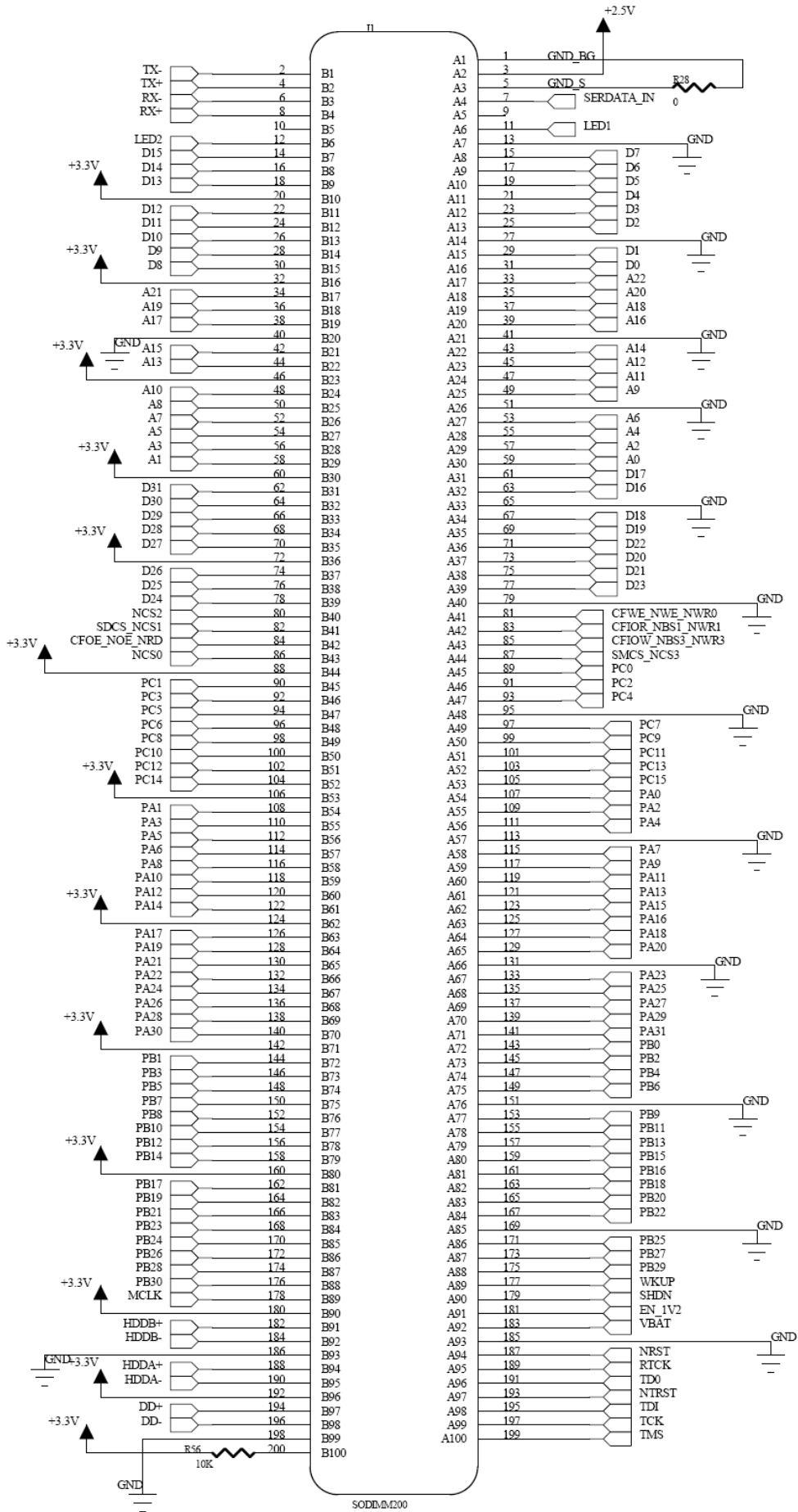

Order Information

Order No.	ME2
Item	Embest Mini9261-I Processor Card
Option hardware	✓ SO-DIMM socket 200-pin (to work with DIMM 200-pin) ✓ SBC9261-I board (choose Embest expansion board for Mini9261-I)
Contact	E-mail: market@embedinfo.com Tel: +86-755-25635656 Fax: +86-755-25616057



Embest Info&Tech Co., LTD.

Room 509, Luohu Science&Technology Building,
 #85 Taining Rd., Shenzhen, Guangdong, China 518020

Tel: +86-755-25635656

Fax: +86-755-25616057

Email: market@embedinfo.com

<http://www.embedinfo.com>

<http://www.armkits.com>